



DM&P Group



eBox-3300 User's Manual

COPYRIGHT

The information in this manual is subject to change without notice for continuous improvement in the product. All rights are reserved. The manufacturer assumes no responsibility for any inaccuracies that may contain in this document, and makes no commitment to update or to keep current information contain in this manual.

No part of this manual may be reproduced, copied, translated or transmitted, in whole or in part, in any form or by any means without the prior written permission of the DMP Electronics Inc.

©Copyright 2008 DMP Electronics Inc.
Manual No.: IUMeBox3300-01 Ver.J1.0

 1st Issued Date: Nov. 10, 2008

SPECIAL NOTICE TO USERS

DMP Electronics Inc. provides no warranty with regard to this manual, the software, or other information contained herein and hereby expressly disclaims any implied warranties of merchantability or fitness for any particular purpose with regard to this manual, the software, or such other information. In no event shall DMP Electronics be liable for any incidental, consequential, or special damages, whether based on tort, contract, or otherwise, arising out of or in connection with this manual, the software, or other information contained herein or the use thereof.

DMP Electronics reserves the right to make any modification to this manual or the information contained herein at any time without notice. The software described herein is governed by the terms of a separated user license agreement or label sticker.

This product contains software owned by DM&P and licensed by third parties. Use of such software is subject to the terms and conditions of license agreements enclosed with this product. Software specifications are subject to change without notice and may not necessarily be identical to current retail versions.

Updates and additions to software may require an additional charge. Subscription to online service providers may require a fee and credit card information. Financial services may require prior arrangements with participating financial institution.

TRADEMARKS ACKNOWLEDGMENT

The eBox-3300 is the registered trademarks of DMP Electronics Inc.

Microsoft®, Windows® and AMI are registered trademarks of Microsoft Corporation and American Megatrends Inc. in the United States and/or other countries respectively.

Other brand names, product names or trade names appearing in this document are the properties and registered trademarks of their respective owners. All names mentioned herewith are served for identification purpose only.

OWNER'S RECORD

The serial number of this product is located at the rear panel of your eBox-3300 series. Refer to the model and serial number when you contact your nearest dealer or DMP offices for services. The Model No. of this product is also indicated on the product label of your gift box as: eBox-3300, eBox-3300-H, eBox-3300-M, eBox-3300-L2, eBox-3300-LS, and eBox-3300-JSK.

SAFETY INFORMATION

WARNING

- ▶ Do not expose eBox-3300 to rain or moisture, in order to prevent shock and fire hazard.
- ▶ Never install eBox-3300 in wet locations.
- ▶ Do not open the cabinet to avoid electrical shock. Refer to your nearest dealer for qualified personnel servicing.
- ▶ Never touch un-insulated terminals or wire unless your power adaptor and display monitor are disconnected.
- ▶ Locate eBox-3300 as close as possible to the socket outline for easy access and to avoid force caused by entangling of your arms with surrounding cables from the eBox-3300.
- ▶ When using eBox-3300, avoid using or installing the modem to the serial port during a storm or a lightning.
- ▶ Do not use the modem or a telephone to report a gas leak in the vicinity of the leak.
- ▶ USB connectors are not supplied with Limited Power Sources.

**DO NOT ATTEMPT TO OPEN OR TO DISASSEMBLE THE CHASSIS
(ENCASING) OF THIS PRODUCT. PLEASE CONTACT YOUR
NEAREST DEALER FOR SERVICING FROM QUALIFIED TECHNICIAN.**

REGULATORY

FCC CLASS A NOTE

This equipment has been tested and found to comply with the limits for a Class A digital device, pursuant to Part 15 of the FCC Rules. These limits are designed to provide reasonable protection against harmful interference when the equipment is operated in a commercial environment. This equipment generates, uses and can radiate radio frequency energy and, if not installed and used in accordance with the instruction manual, may cause harmful interference in which case the user will be required to correct the interference at his own expense. Testing was done with shielded cables. Therefore, in order to comply with the FCC regulations, you must use shielded cables with your installation.

WARNING

This product complies with EN55022 class A. In a domestic environment this product may cause radio interference in which case the user may be required to take adequate measures.

Changes or modifications to this unit not expressly approved by the party responsible for compliance could void the user's authority to operate the equipment.

This device complies with Part 15 of the FCC rules. Operation is subject to the following two conditions: (1) this device may not cause harmful interference, and (2) this device must accept any interference received, including interference that may cause undesired operation.

This digital apparatus does not exceed the Class A limits for radio noise emissions from digital apparatus as set out in the interference - causing equipment standard entitled "Digital Apparatus", ICES-003 of the Department of Communications.

MANUFACTURER'S DECLARATION OF CONFORMITY

This equipment has been tested and found to comply with the requirements of European Community Council Directives 89/336/EEC and 73/23/EEC relating to electromagnetic compatibility and product safety respectively.

ATTENTION

This product has been designed and certified to comply with certain regulatory requirements pertaining to Information Technology Equipment. This product has not been designed for use as a medical device. Without limitation of the foregoing, this product is not intended and has not been certified for use in a hospital or clinical environment to diagnose, treat, or monitor patients under medical supervision, and is not intended and has not been certified to make physical or electrical contact with patients, nor to transfer energy to or from patients and/or to detect such energy transfer to or from patients.

PURCHASE AGREEMENT

PURPOSE:

In accordance to the general commercial conduct of Trust and Fair Trade, herewith below is the agreement for the protection for both parties, DMP and Users in pursuant of trading.

PRODUCT DESCRIPTION:

With this product, herewith also known as eBox-3300, which is a simplified & an economical design of an embedded eBox-3300 for Special Purpose Personal Computing. The basic specification of this product comprises of the x86 technology design, and with onboard 256MB System memory, VGA display, USB, PS/2 Keyboard, Mouse, LAN, and Audio Interfaces.

DISTRIBUTION CONVENTION:

1. This Product includes a gift box, an inner case, a PC, a Power adaptor, (and IDE cable will be included only for eBox-3300-H package). Upon receiving this product, kindly please refer to the User' Manual to check for the contents and appearance of this product; contact immediately your nearest dealer or DMP office for any defective or missing parts. The supplier will not be responsible for any reported discrepancy thereafter the expiration period of 3-days from the date of purchase.
2. In consideration of transportation and the cost of storage, the supplier provides to the distributors a warranty of 12-months. This warranty covers the failure caused by hardware breakdown (excluding hard drives), but does not cover the act of misuse and mishandling.
3. The supplier will not accept unknown post, therefore if you wish to repair or to return your goods – kindly please contact your nearest dealer to make your declaration, and at the same time, apply for a RMA number (RMA stands for Return Merchandise Authorization – please see the RMA form and fill-up for authorization).
4. The freight for return goods for repair will follow the International customary practice and convention: Both parties is to pay for freight of one shipment each. The shipper is required to prepay the freight from the place of origin (This means that the returnee (user) covers the freight for return goods, while the Supplier covers the freight for goods after the repair).
5. Obsolete warranty is referred to as: (1) Expiration of warranty or (2) Damage due to misuse within warranty. The Supplier will be taken into consideration of the circumstances, to provide repair service with charges expense for obsolete warranty. This expense includes the cost of material and the cost of labor.

NOTE:

If there is other particular issue not listed in the above conditions, both parties agreed to follow the General Law of Commerce with fair and reasonable discussion in handling and resolving the argument.

Table of Contents

<u>CHAPTERS – HEADING</u>	<u>PAGE NO.</u>
0 – UNPACKING YOUR EBOX	1
▶ PACKING LIST	1
▶ CHECK BEFORE USE	1
1 – PREFACE	2
2 – eBox-3300 OVERVIEW	3
3 – EMBEDDED CPU BOARD	4
▶ SYSTEM SPECIFICATION	4
4 – PERIPHERALS	5
▶ CONNECTING THE POWER ADAPTOR	5
▶ CONNECTING THE MONITOR	5
▶ CONNECTING THE USB	6
▶ CONNECTING USB, SPEAKER/EARPHONE & WEB	6
▶ CONNECTING THE KEYBOARD AND MOUSE	7
▶ CONNECTING SERIAL PORT	7
5 – BIOS	8
▶ RECONFIGURING eBox-3300	8
6 – TECHNICAL SPECIFICATION	9
7 – TAKING CARE YOUR VESA PC	10
▶ STORING	10
▶ USING CABLES FOR CONNECTION.....	11
▶ CLEANING YOUR VESA PC	11
8 – TROUBLESHOOTING.....	12
▶ TROUBLESHOOTING YOUR EBOX	12
▶ VESA PC DOES NOT START.....	12
▶ BIOS ERROR MESSAGE.....	12
▶ “OPERATING SYSTEM NOT FOUND”	13
APPENDIX : ONBOARD CONNECTORS SUMMARY	14

▶ SUMMARY TABLE FOR CPU BOARD.....	14
▶ FRONT CONNECTORS OUTLINE FOR eBOX-3300.....	14
▶ REAR CONNECTORS OUTLINE FOR eBOX-3300	15
▶ PIN ASSIGNMENTS	16
WARRANTY : TERMS AND CONDITION	18
1 WARRANTY	18
2 SERVICE AND SUPPORT	18
3 RETURN MERCHANDISE AUTHORIZATION (RMA) POLICY	18
4 SHIPPING POLICY	18

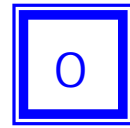

UNPACKING YOUR EMBEDBOX

Congratulation! You have just acquired eBox-3300, the world's smallest and compact PC (See Figure 1), please check the following items:

PACKING LIST FOR eBOX-3300 SERIES

Item	Description	Q'ty
①	eBox-3300 VESA PC	1
②	Max. 10-watts External Power Adaptor, Vin: 100~240VAC • 50/60Hz, 0.45A / Vout: +5.0~5.25VDC @ 2A max.	1

* Note: The accessories are subject to change without immediate notice.

CHECK BEFORE USE



Figure 1

PREFACE

eBox-3300: VESA PC



The eBox-3300 is a revolutionary device which is especially designed for limited physical space and temperature concerns. No matter you are in a jammed office, a crowded place, or public transportation, it can be easily integrated with a VESA LCD to bring you eBox-3300 access at any time.

It can attach to any VESA mounting fixture, allowing it to be securely mounted onto desks, walls, or buildings, and thereby optimizes your work area. It can also attach directly to any size LCD for a mobile system for the use at trade shows, presentations, promotions, etc. Unlike traditional portable laptop design, the eBox-3300 can be used with a large size LCD. Furthermore, with FANLESS design, eBox-3300 is ideal to be used in the environment where temperature demand is critical.

So, if you are looking for a device that is able to provide you with more mobility & space but at the same time uses less power consumption, then eBox-3300 will be surely meet your need.

The VESA® FDMI™ Standard defines mounting interfaces, hole patterns and associated cable/power supply locations for LCD monitors, plasma displays and other flat panel devices. eBox-3300 is designed to fit this standard to make monitor attachment quick and easy.

eBox-3300 Overview

Front Panel



Power LED

The power LED lights up when system is turn on.

HDD LED

The HDD LED flashes when the system is working. Never turn off the power when HDD LED is still flashing.

CF and Micro SD Slot

The system is bootable from Compact Flash Card and Micro SD (T-flash).

Audio Line Out

Output to speaker

Audio Mic In

For Microphone Input

USB port

For connection to devices with USB interface (HDD, CD/DVD-ROM, Memory Stick, etc.)

Back Panel

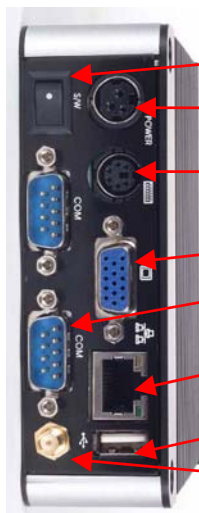

▶ Power switch

▶ DC Power Jack (3-pin)

▶ PS/2 Keyboard or Mouse (6-pin)

▶ VGA

▶ RS-232 (optional for eBox-3300-JSK)

▶ RJ-45 LAN Jack

▶ USB Port

▶ Wireless Antenna connector (optional)

□ About Embedded CPU Board

SYSTEM SPECIFICATION

CPU

Vortex86DX SoC (System on Chip)

Main Memory

256MB DDR2

BIOS

AMI BIOS

VGA

XGI Z9S with 32MB DDR2

Resolution up to 1,280x1,024 High Colors

Audio

Mic In, Line Out

Keyboard and Mouse

PS/2 Keyboard and Mouse

On-Board IDE

Enhanced IDE interface, 44-pin box header x 1

Peripheral

1. USB V2.0 (host) x 3
2. Audio (Mic In, Line Out)
3. Type I/II CF Slot and Micro-SD
4. Serial ports x 2 (available for eBox-3300-JSK)
5. Mini PCI socket x1 (available for eBox-3300-M and 3300-JSK)
6. 2nd RJ-45 LAN (only available on eBox-3300-L2)

Dimension & Weight

115 x 115 x 35 mm / 505g

Operating System

Suitable for:

Windows XP

Windows XP Embedded

Windows Embedded CE

Linux

PERIPHERALS

CONNECTING THE POWER ADAPTOR



Power Adaptor

To use eBox-3300 immediately, please attach the supplied AC adaptor as a power source. See the left diagram for visual connection.

Connect the DC power jack of the power adaptor to the DC Input jack of eBox-3300.



Turning ON eBox-3300

Switch on power as indicated on the figure on your left-side, the system will start automatically.

CONNECTING THE MONITOR



VGA Connection

Depending on your choice of viewing, select a conventional CRT or the LCD VGA monitor.

Make your connection by following the reference diagram from the VGA cable of your cable to the 15-pin D-Sub VGA port of eBox-3300.

PERIPHERALS

CONNECTING THE USB AND SPEAKER/EARPHONE

eBox-3300 provides USB port (Two in front & one at the back).

Front cabinet



USB Ports

The USB ports is available for connection to USB devices such as CD-ROM

Microphone/Earphone

The eBox-3300 supports for Microphone Input and Speaker Output

Micro-SD and CF slot

For connection to Device with Compact Flash Card and Micro-SD (T-flash).

Secondary IDE Master/Slave

Adjust for Compact Flash device to be Secondary IDE Master or Slave

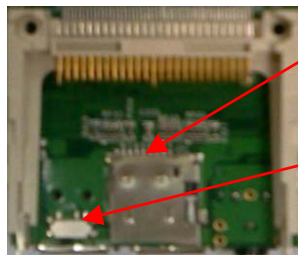

(Inside CF slot)

CONNECTING THE LAN



Connecting to LAN

There is an available RJ-45 LAN jack for connection to the hub of your intranet; and via your server for internet service (see diagram for RJ-45 LAN jack).

CONNECTING THE KEYBOARD AND MOUSE



PS/2 Keyboard or Mouse (6-pin)

The PS/2 Port is available for connecting Keyboard/Mouse (shared)

CONNECTING SERIAL PORT



Serial Ports

The serial port is usually connected to a serial device like modem (option for eBox-3300-JSK)

BIOS

RECONFIGURING eBox-3300

1. Take note that AMI BIOS is used in the eBox-3300. To reconfigure the eBox-3300, depress or hit the key to enter your BIOS setup main menu.
2. Select from the menu, the desired setup for change.
3. Press <Esc> to go back to main menu.
4. Move "Exit" TAB and select "Save Settings and Exit", press "Y" to save the changes that you just made. eBox-3300 will restart accordingly to your new setup.

```

Main  Advanced  PCIPnP  Boot  Security  Chipset  Exit
*****
* System Overview *
* ***** *
* Processor *
* Vortex A9120 *
* Speed :1000MHz *
* *
* System Memory *
* Size :256MB *
* Speed :366MHz *
* *
* System Time [08:54:15] *
* System Date [Wed 11/12/2008] *
* *
* ** Select Screen *
* ** Select Item *
* +- Change Field *
* Tab Select Field *
* F1 General Help *
* F10 Save and Exit *
* ESC Exit *
* *
*****
v02.58 (C)Copyright 1985-2008, American Megatrends, Inc.

```

(AMI BIOS Setup menu)

TECHNICAL SPECIFICATION

Features	Description
CPU	Vortex86DX SoC
BIOS	AMI BIOS
System Memory	Onboard 256MB DDR2
Expansion	1x Mini-PCI connector *
I/O	
MIO	1 x EIDE (44-pin) 1 x Type I/II Compact Flash slot 1 x Micro SD slot 1 x RJ-45 Ethernet Connector 1 x 2 nd RJ-45 Ethernet ** 2 x RS-232***, 1 x PS/2 for K/B or Mouse
USB	3 x USB 2.0 Ports (two in front)
Audio	
Integrated Audio	Mic In x 1, Line Out x 1
Display	
VGA	XGI Z9S with 32MB DDR2 External 15-pin D-type female VGA connector
Resolution	Up to 1280x1024
Ethernet	
Remote Boot ROM	Integrated 10/100Mbps LAN Built-in PXE diskless boot function ** Chipset (2 nd) Realtek RTL8100B 10/100 Base-T Ethernet
Mechanical & Environment	
Power Requirement	+5V @ 2A
Operating Temperature	5 ~ 50° C
Operating Humidity	0% - 90% relative humidity, non-condensing
Size (W x H x D)	115 x 115 x 35 mm
Weight	505g
Certification	CE, FCC

Note:

* Mini-PCI Connector is available for eBox-3300-M and eBox-3300-JSK

** 2nd RJ-45 Ethernet *** is only available on eBox-3300-L2

*** RS-232 is available for eBox-3300-JSK and eBox-3300-L2

TAKING CARE eBox-3300

This section gives you guidelines on using eBox-3300 – Safe using, Storing and Handling.

STORING

- ▶ Do not place eBox-3300 in a location that is subject to:
 - Heating sources, such as stove, oven, heater, radiator or air duct
 - Direct contact from sunlight
 - Rain or moisture area
 - Excessive dust accumulation area
 - High humidity place
 - Constant or occasional mechanical movement, vibration or shock
 - Strong magnets or magnetic fields or magnetically unshielded speakers
 - Ambient temperature of more than 95°F (35°C) or less than 32°F (0°C)
- ▶ Do not place other electronic device or electrical equipment near eBox-3300. The electromagnetic field of the eBox-3300 may cause interference subjecting to malfunction.
- ▶ Provide adequate air ventilation (circulation) to prevent internal buildup of heat. Do not place eBox-3300 near the wall, behind the curtains or draperies, in between two books that block its ventilation slots. Leave a space of at least 8 inches (20cm) behind the sides and back panel of the eBox-3300.
- ▶ Change of environmental temperature: Problems may occur when there is a sudden change of environmental temperature, or if the eBox-3300 is brought directly from a cold location to a warm one, moisture may condense inside eBox-3300. Turn off eBox-3300, and contact your nearest dealer.
- ▶ Checking the surrounding appliance(s) before using eBox-3300. Since the eBox-3300 uses high-frequency radio signal and may interface with radio or TV reception causing interference or poor signal display. When this happens, relocate the eBox-3300 by a suitable distance away from the set.
- ▶ Do not drop the eBox-3300 from the working table nor place heavy objects on top of the eBox-3300.

USING CABLES FOR CONNECTION

- ▶ To avoid problem, use only the specified interface cables in your accessory bag. The supplier will not be responsible for the connection arising from the other unspecified peripheral equipment.
- ▶ Do not use cut or damaged cables for connection.

CLEANING YOUR VESA PC

- ▶ Clean the eBox-3300 with a soft, dry cloth or a soft cloth lightly moistened with a mild detergent solution.
- ▶ Do not use any type of abrasive pad, scouring powder, or solvent such as alcohol or benzene, as these may damage the finish of eBox-3300.
- ▶ When a solid object falls or a liquid spills onto the eBox-3300, turn off the eBox-3300 immediately and unplug the LAN and power cables. Contact a qualified person or your dealer to check the eBox-3300 before you use it again.
- ▶ Always disconnect the power cord from the power source before cleaning the eBox-3300.

TROUBLESHOOTING

This section describes the techniques of resolving some basic problems that you encounter when using eBox-3300. For more troubleshooting guidelines, please contact your nearest dealer for technical support.

TROUBLESHOOTING YOUR VESA PC

A. VESA PC does not start

- ▶ Make sure the eBox-3300 is properly secured and plugged into a power source before it is turned on. Make sure the power indicator shows the power is on. See section 2 for more information about “eBox-3300 Overview”.
- ▶ When the eBox-3300 is plugged into a power strip or the UPS (Uninterruptible Power Supply), make sure the power strip or UPS is turned on and working normally.
- ▶ Check if your VGA or LCD monitor is properly plugged into a power source and turned on. Make sure the brightness and contrast controls are adjusted correctly. See the manual that came with your display (monitor) for details.
- ▶ Check if your power control button does not function, by removing the AC adaptor. Wait for one minute, and then reattach all power connection before pressing the power button.
- ▶ Condensation may cause the eBox-3300 to malfunction for a while. If this happens, do not use the eBox-3300 for at least one hour.
- ▶ When you have checked all the above guidelines and the eBox-3300 does not work. Remove the power adaptor from the eBox-3300, unplug the power cord, and plug it in again. Then turn on the power.

B. BIOS Error Message –

BIOS error message appear when my VESA PC starts

If the BIOS error message appears, press any key to resume or, hit to enter BIOS setup main menu, follow these steps:

1. Press , and the BIOS Setup main menu appears, check if HDD is detected at “Pri Master”. If it is not detected, use Direction keys <↑↓> to choose “AUTO” and then go back to the main menu by pressing <ESC>. Move your cursor down with Direction keys <↓>, and choose “Save Settings and Exit”, a message dialog appears as seen below, hit <Enter>.

“Save current settings and exit (Y/N)? Y”

2. Go to “Exit” menu using the Direction keys <↑↓> and choose the option “Load Optimal Defaults”, then press <Enter>. A message dialog appears as seen below, hit “Y” key and press <Enter> to save and recover to the factory setting.

“Load Optimal Defaults (Y/N)? Y”

```

Main   Advanced  PCIPnP  Boot   Security  Chipset  Exit
*****
* Exit Options
* *****
* Save Changes and Exit
* Discard Changes and Exit
* Discard Changes
* *****
* Load Optimal Defaults
* Load Failsafe Defaults
* Load Optimal Defaults?
* [Ok] [Cancel]
* *****
* Select Screen
* Select Item
* Enter Go to Sub Screen
* F1 General Help
* F10 Save and Exit
* ESC Exit
* *****
v02.58 (C)Copyright 1985-2008, American Megatrends, Inc.

```

(BIOS Setup menu "Exit")

C. "Operating System Not Found" –

A message indicating that "Operating system not found" appear when my VESA PC starts (Windows won't start)

- ▶ Enter your BIOS setup main menu by pressing key, be sure that your C: drive is enable.
- ▶ If Windows still does not start, follow these steps to initialize the BIOS:
 1. Turn off the eBox-3300.
 2. Remove any peripheral devices connected to the eBox-3300.
 3. Restart the eBox-3300..
 4. Press to enter **BIOS Setup main menu** window.
 5. Follow the steps as written in item **B. BIOS error message**.
- ▶ **For eBox-3300** : If you have just connect eBox-3300 to a CD/DVD or USB Drivers, remove these peripherals.. And restart eBox-3300 to confirm that the Windows operating system starts properly. If eBox-3300 continues to display the message "Operating system not found," and Windows does not start, please contact your nearest dealer for servicing.

ONBOARD CONNECTORS SUMMARY

SUMMARY TABLE FOR CPU BOARD

Nbr	Description	Type of Connections	Pin nbrs.
J1	IDE connector	Box Header 22x2 2.0mm	44-pin
J3	USB (Back)	USB Connector	8-pin
J4	USB (Front)	USB Connector	8-pin
J5	USB (Front)	USB Connector	8-pin
J6	JTAG connector	Wafer 1.25mm	6-pin
J8	PS/2 keyboard or Mouse	Mini DIN Connector	6-pin
J9	COM1 Port	Box Header 5x2 2.0mm	10-pin
J11	COM2 Port	Box Header 5x2 2.0mm	10-pin
J12	DC 5V Input	Mini-Din Connector	3-pin
J14:	Mini PCI	Mini PCI socket	124-pin
J15	VGA Connector	D-Sub Connector	15-pin
J18	Secondary IDE Master	Dip Switch	2-pin
J19	Line-Out	Audio Jack	2-pin
J20	Microphone	Audio Jack	2-pin
JP1	JTAG enable	Jumper	2-pin
LAN	Ethernet LAN	RJ-45	8-pin

► FRONT CONNECTORS OUTLINE FOR eBox-3300

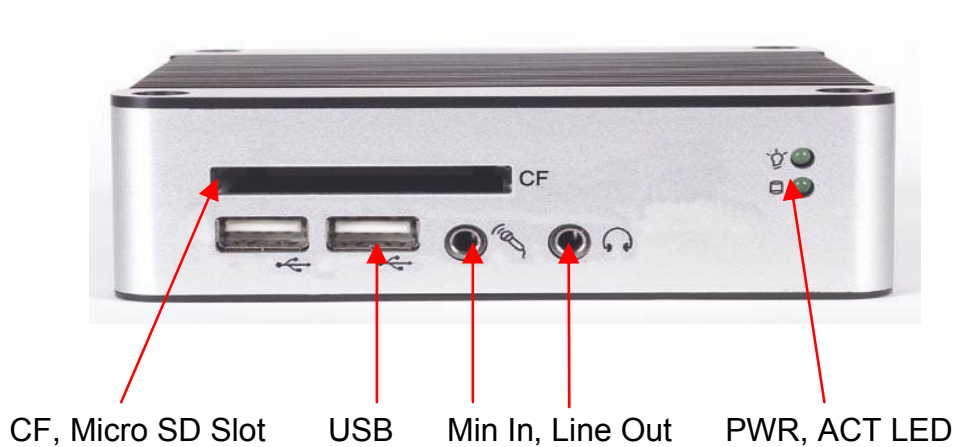

► REAR CONNECTORS OUTLINE FOR eBox-3300

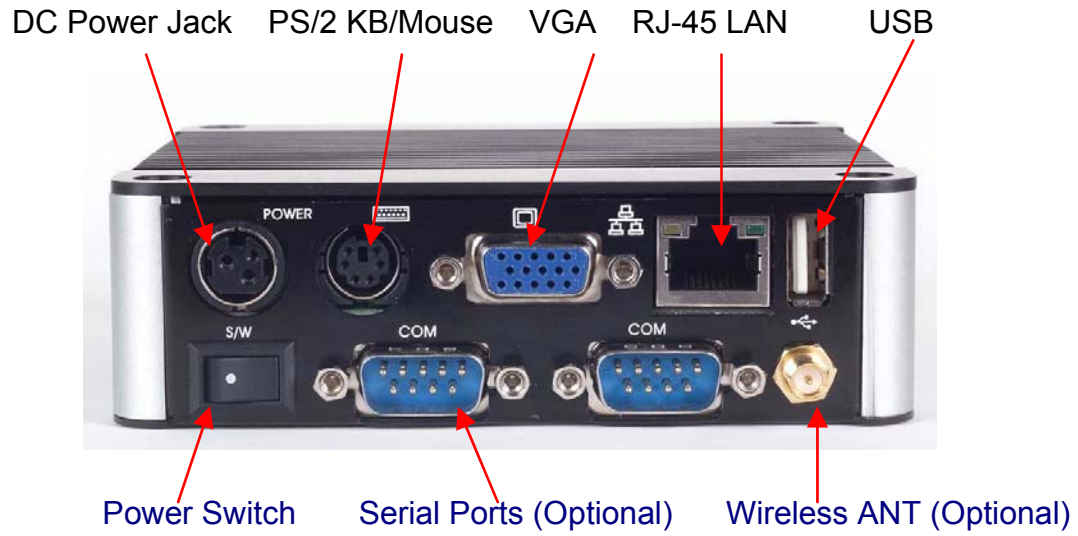

► PIN ASSIGNMENTS

J8:PS/2 Keyboard or Mouse – 6-pin Mini-Din Connector

Pin #	Signal Name
1	KBCLK
2	PMCLK
3	GND
4	KBDAT
5	PMDAT
6	SB5V

Power SW – Push Button Switch

Pin #	Status
I	ON
O	OFF

J12: DC-IN (5V) – 3-pin Mini-Din Lock Pin Socket

Pin #	Signal Name
1	VCC
2	GND
3	NC

J3: USB (90°)– 4-pin USB Type 1 Connector (Vertical Type)

Pin #	Signal Name
1	VCC
2	USB0-
3	USB0+
4	GND
5	GGND
6	GGND

LAN: RJ-45 Connector

Pin #	Signal Name	Pin #	Signal Name
1	FTXD+	2	FTXD-
3	FRXIN+	4	NC
5	NC	6	FRXIN-
7	NC	8	NC

► PIN ASSIGNMENTS

J15: VGA – 15-pin D-Sub Connector

Pin #	Signal Name	Pin #	Signal Name	Pin #	Signal Name
1	MR	6	GND	11	NC
2	MG	7	GND	12	VCC
3	MB	8	GND	13	HYSYNC
4	NC	9	NC	14	VSYNC
5	GND	10	GND	15	VCC

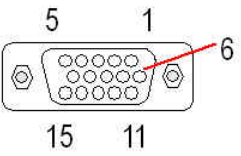

J4,J5:USB (USB2): For connection to external USB device –4-pin USB Type 1 Connector (H)

Pin #	Signal Name
1	VCC
2	USB2-
3	USB2+
4	GND
5	NC
6	NC

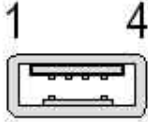

LEDS: POWER ON/OFF & HDD R/W

LED Color	State
Green	Power On
Green	HDD On
Green Flashes	HDD R/W



J9,J11: COM - 9-pin D-Sub Connector

Pin #	Signal Name	Pin #	Signal Name
1	DCD1	2	RXD1
3	TXD1	4	DTR1
5	GND	6	DSR1
7	RTS1	8	CTS1
9	RI1	--	--

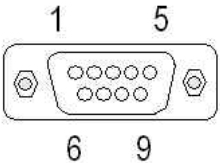

TERMS AND CONDITIONS

1. Warranty

The warranty terms for eBox-3300 are twelve (12) months from the beginning on the date of invoice. During the warranty period, DMP Electronics Will repair replace the product covered under this limited warranty.

2. Service and Support

DMP Electronics Inc. provides the technical support for hardware problems with your system throughout the warranty period. The technical support service is limited to configuration and operation of eBox-3300 sold by DMP Electronics Inc. The technical support service does not offer software tutoring or training.

3. Return Merchandise Authorization (RMA) policy

If the DMP staff or dealer determines that a part is defective. Purchaser must call our technical support service to obtain an RMA number before attempting to return any part. Please refer to your nearest dealer for

To obtain an RMA number, Purchaser must follow procedures as below :

1. Complete the DMP Electronics Inc. standard RMA Form and fax back to the RMA Department.
2. The RMA Number must be used within 7 DAYS
3. The RMA Number must be shown clearly on your shipping label.
4. DMP Electronics Inc. must receive all Returns before a replacement will be sent.
5. The repair cost is depends on the parts, the damage reasons, and whether under warranty period...etc. The Seller will charge the Purchaser in a reasonable price.
6. A copy of the invoice for the RMA product(s) will also be shipped to Purchaser.
7. The freight of return to Media Stream Tech. is charges to Purchaser account and accompanied by an RMA number. Any Returns with freight collect will be refused and returned to you. After Repairing, the cost of freight will be paid by Seller.
8. DMP Electronics Inc. must receive all returned goods within the warranty period.

4. Shipping Policy

The Purchaser must pre-pay shipping for any defective system or parts returned under the warranty. DMP Electronics Inc. shall not be liable for risk of loss or damage during shipment of your returned system or parts if you fail to insure the shipment.

All products must be shipped back to DMP Electronics Inc. in original or equivalent packaging. DMP Electronics Inc. will ship the repaired or replacement product(s) to Purchaser by freight prepaid. Purchaser assumes the risk of loss. DMP Electronics Inc. shall not be responsible for failure of the delivery service to make on-time delivery.

MEMO
